



**FEATURE**

- Earth Fault Current Monitoring In 1Ø - 2W, 3Ø-3W And 3Ø-4W System
- Test Mode Available.
- Remote Tripping Reset Facility.
- Relay Status Indication By LED
- Test/Trip Reset Via Front Key / Remote

**TECNICAL SPECIFICATION**

**INPUT SPECIFICATION :**

<b>Input Current</b>	5 Amp. AC From CBCT OR CT
<b>Range</b>	10% to 100%
<b>Resolution</b>	1 %

**DISPLAY & KEYS :**

<b>Display</b>	3 Digit, 7 Seg., 0.36", Red.
<b>Keys</b>	SET, INC, DEC.

**OUTPUT SPECIFICATION :**

<b>Relay</b>	1 Nos.
<b>Relay Type</b>	NO - C
<b>Rating</b>	5A,230V AC Resistive Load

**AUXILIARY SUPPLY :**

<b>Supply Voltage</b>	100 To 270 V AC
<b>Power Consumption (VA Rating)</b>	3VA @ 230 VAC MAX

**ENVIRONMENT CONDITION :**

<b>Operating Temp.</b>	0 - 55°C
<b>Relative Humidity</b>	95% RH

**MECHANICAL DIMENSION**

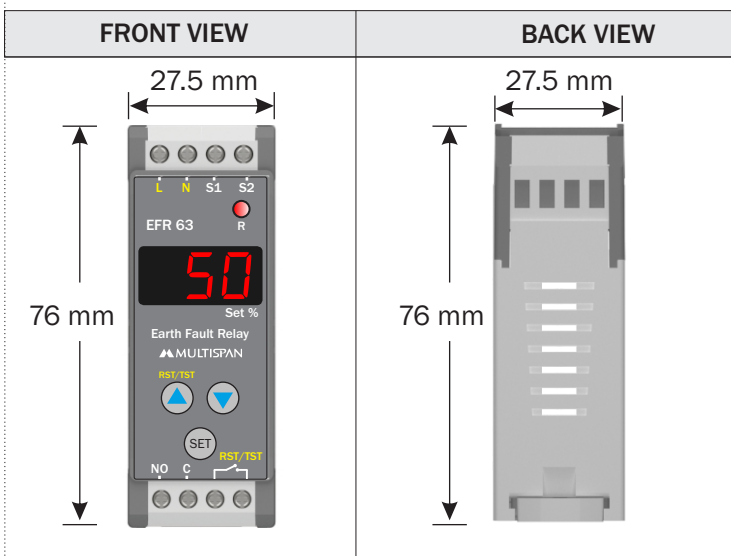



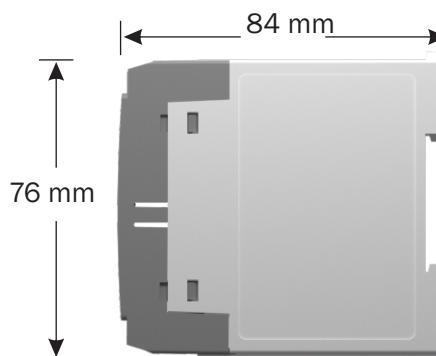

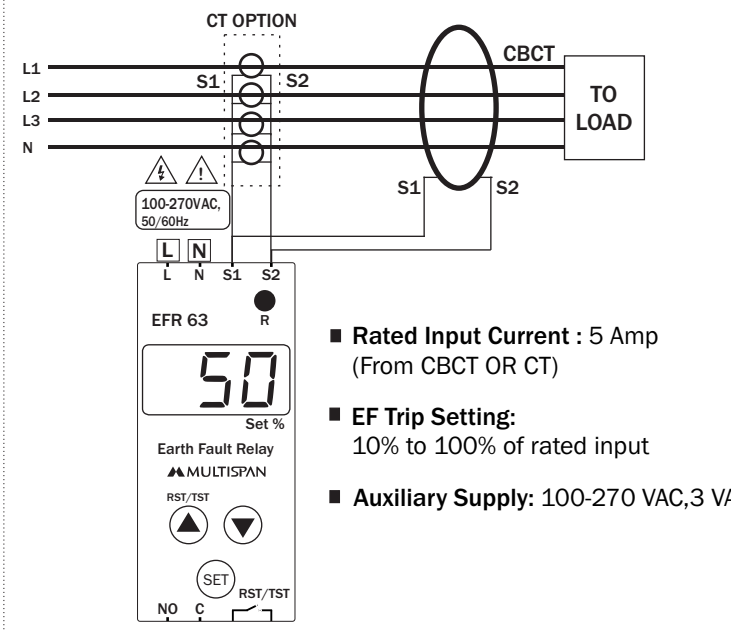

**SIDE VIEW**



**TERMINAL CONNECTION**



## KEY OPERATION

FUNCTION	KEY PRESS
<b>OPERATION MODE</b>	
To Enter in Parameter Setting	
To Enter in Test Mode	 For 5 sec
To Reset the Relay Contact Manually After Tripping	 For 2 sec
<b>PARAMETER SETTING MODE</b>	
To Increment Parameter Value	
To Decrement Parameter Value	
To Save & Exit From Parameter Setting Mode	 For 3 sec

## MECHANICAL INSTALLATION

- 1) To install the instrument on a DIN rail, raise the clamp at the back of the instrument and place it on the rail. Now release the clamp, so the instrument fits on the DIN rail.
- 2) Ensure proper fitting of the instrument by pulling it outwards.
- 3) To remove the instrument raise the clamp to release it from the DIN rail.
- 4) The equipment in its installed state must not come in close proximity to any heating source, caustic vapors, oil steam, or other unwanted process byproducts.
- 5) Do not connect anything to unused terminals.

## MAINTENANCE

- 1) The equipment should be cleaned regularly to avoid blockage of ventilating parts.
- 2) Clean the equipment with a clean soft cloth. Do not use isopropyl alcohol or any other cleaning agent.
- 3) Fusible resistor must not be replaced by operator.



## SAFETY PRECAUTION

All safety related codifications, symbols and instructions that appear in this operating manual or on the equipment must be strictly followed to ensure the safety of the operating personnel as well as the instrument.

If all the equipment is not handled in a manner specified by the manufacturer, it might impair the protection provided by the equipment.



Read complete instructions prior to installation and operation of the unit.



**WARNING : Risk of electric shock.**

## INSTALLATION GUIDELINES

- 1) Do not allow pieces of metal, wire clippings, or fine metallic fillings from installation to enter the product or else it may lead to a safety hazard that may in turn endanger life or cause electrical shock to the operator.
- 2) Circuit breaker or mains switch must be installed between power source and supply terminal to facilitate power 'ON' or 'OFF' function. However this mains switch or circuit breaker must be installed at convenient place normally accessible to the operator.
- 3) Use and store the instrument within the specified ambient temperature and humidity ranges as mentioned in this manual.

## WARNING GUIDELINES



**WARNING : Risk of electric shock.**

- 1) To prevent the risk of electric shock, power supply to the equipment must be kept OFF while doing the wiring arrangement. Do not touch the terminals while power is being supplied.
- 2) To reduce electro magnetic interference, use wire with adequate rating and twists of the same of equal size shall be made with shortest connection.
3. Cable used for connection to power source, must have a cross section of 1mm or greater. These wires should have insulations capacity made of at least 1.5kV.
- 4) A better anti-noise effect can be expected by using standard power supply cable for the instrument.

## PARAMETER SETTING

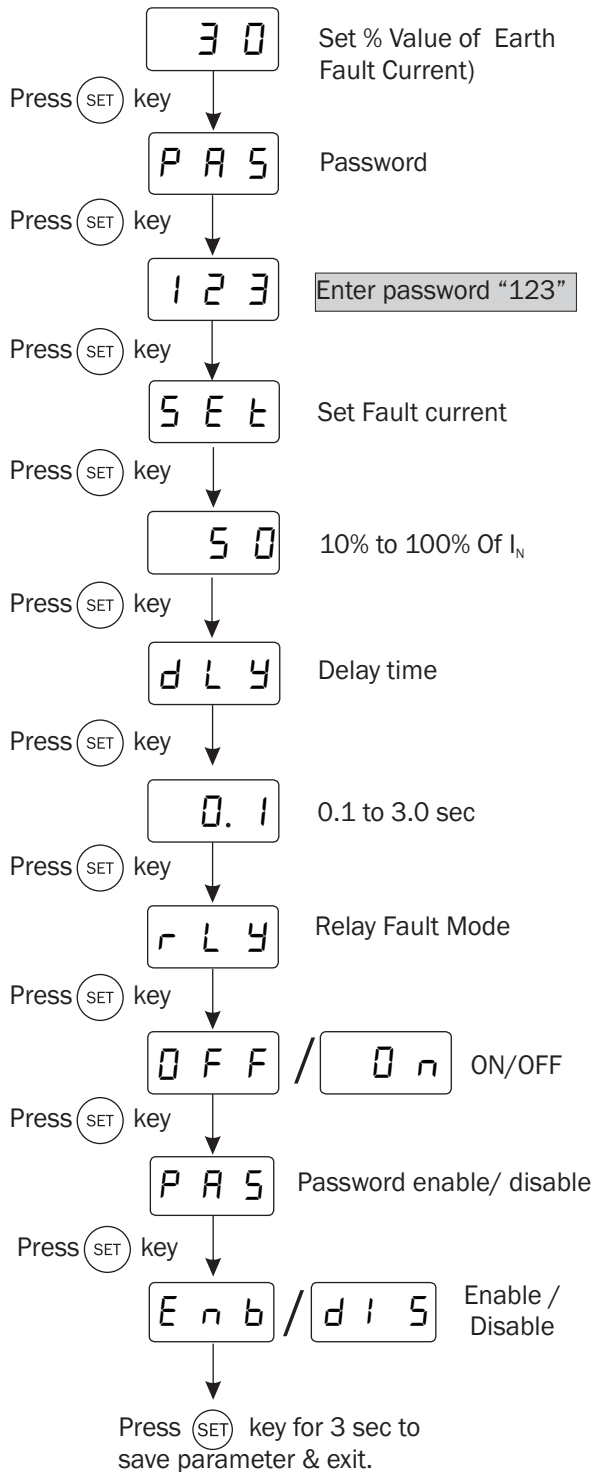

## TEST MODE

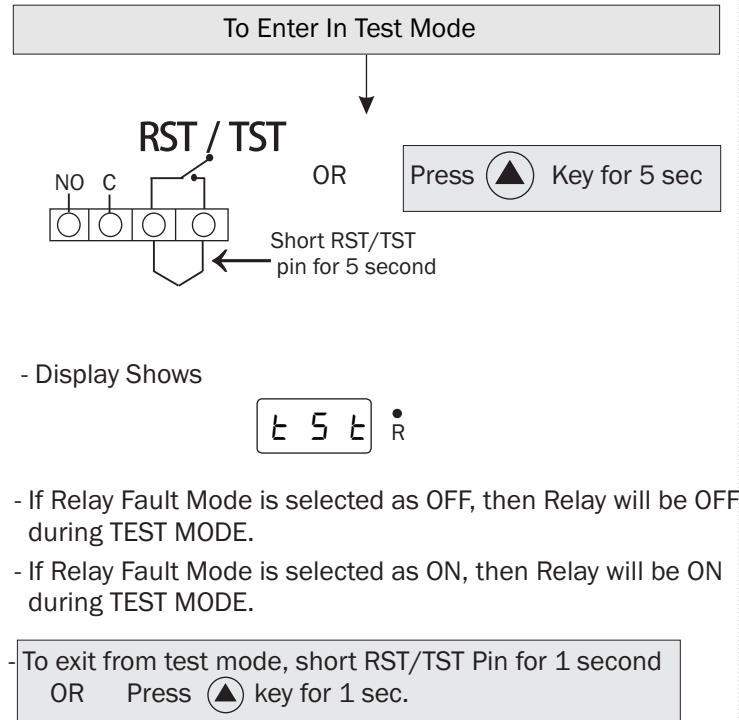

## RESET FUNCTION

To Reset the Relay Contact after tripping two Reset option are given.

### 1) Remote/Terminal Reset

NOTE: When Leakage Current < Setpoint

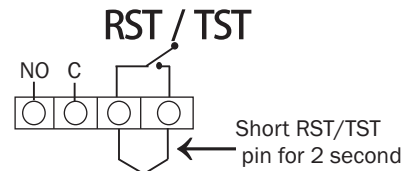

### 2) Front key Reset

Press (▲) Key for 2 Second

# TRIP FUNCTION

Relay Fault Mode = OFF

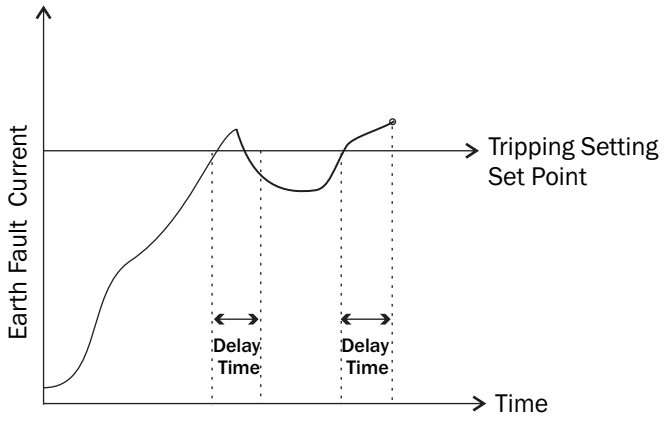

RLY-ON	TRIP
--------	------

Relay Fault Mode = ON

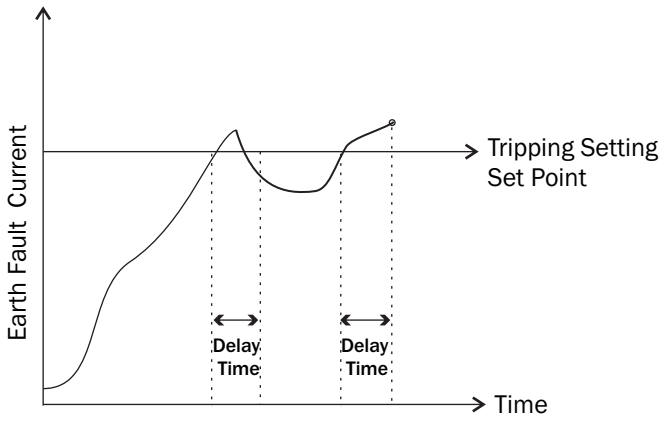

RLY-OFF	TRIP
---------	------

Specifications are subject to change, since development is a continuous process.  
So for more updated operating information and Support,  
Please contact our Helpline: 9978991476/9978991482/9978991474 or  
Email at [service@multispanindia.com](mailto:service@multispanindia.com) Ver:200206