

CURRENT PROTECTION RELAY

MULTISPAN

CPR 126-1C



TECHNICAL SPECIFICATION

FEATURES:

True RMS Measurement
Protection available
<ul style="list-style-type: none"> • Over Load • Under Load
Auto/Manual /ZVR (Zero Value Reset) reset option
3 digit bright LED display
Three phase current display with LED indication
Auto save out feature
Time parameter : Power on delay Trip delay Initial time delay Recovery time (Auto reset)

INPUT SPECIFICATION:

Primary CT value	5 to 999 Selectable
Secondary current AC	0.5 to 5 Amp AC
Resolution	0.01A, 0.1A, 1A

DISPLAY AND KEY:

Display	3 digit, 1line, 7 seg, 0.4" RED LED
Keys	SET, INC, DEC/ RST

OUTPUT SPECIFICATION:

Relay	1 nos.
Relay Type	1 C/O (NO-C-NC)
Rating	10A, 230V AC/28 V DC

ACCURACY

Class 1.0 (Standard)

GENERAL SPECIFICATION:

Dimension (mm)	75 (H) x 45 (W) x 110 (D) mm
Trip Setting	Under current : 0.00 to 100% of primary C.T value Over current : 0.00 - 125% of primary C.T value
Time parameter	Trip delay time : 0 to 999 sec Power on time : 0 to 99 sec Initial time delay : 0 to 99 sec Recovery time : 0 to 99 sec

AUXILIARY SUPPLY:

Supply voltage	100 to 270V AC, 50-60Hz
Power consumption (VA RATING)	3 VA @ 230V AC MAX

ENVIRONMENT CONDITION:

Operating Temp.	0°C to 55°C
Relative Humidity	UP to 95% RH (non-condensing)



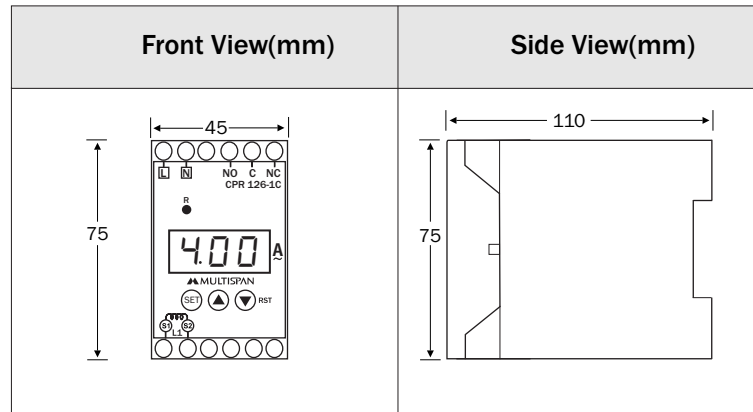

MECHANICAL INSTALLATION

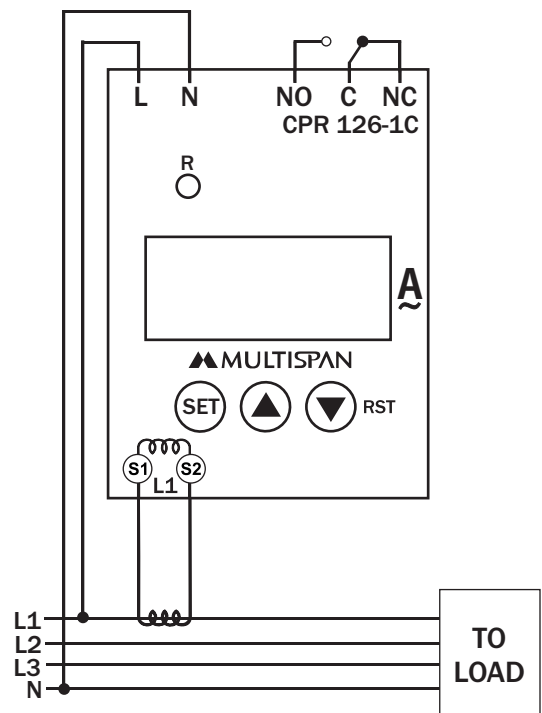

TERMINAL CONNECTION



KEY OPERATION

FUNCTION	PRESS KEY
OPERATOR MODE	
To enter in parameter setting	 For 5 sec
To reset the relay contact in manual mode after tripping	 RST
PARAMETER SETTING MODE	
It is used to set parameter value and to be save & exit from menu	
To increment value in parameter setting	
To decrement value in parameter setting	 RST

LED INDICATION

Relay	● R
-------	-----

DISPLAY PAGE

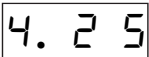
1) L1-Phase current <div style="text-align: center;">   </div>
--

MAINTENANCE

1. The equipment should be cleaned regularly to avoid blockage of ventilating parts.
2. Clean the equipment with a clean soft cloth. Do not use isopropyl alcohol or any other cleaning agent.
3. Fusible resistor must not be replaced by operator.

MECHANICAL INSTALLATION GUIDELINES

- 1) To install the instrument on a DIN rail, raise the clamp at the back of the instrument and place it on the rail. Now release the clamp, so the instrument fits on the DIN rail.
- 2) Ensure proper fitting of the instrument by pulling it outwards.
- 3) To remove the instrument raise the clamp to release it from the DIN rail.
- 4) The equipment in its installed state must not come in close proximity to any heating source, caustic vapors, oil steam, or other unwanted process byproducts.
- 5) Do not connect anything to unused terminals.

INSTALLATION GUIDELINES

- 1) Do not allow pieces of metal, wire clippings, or fine metallic fillings from installation to enter the product or else it may lead to a safety hazard that may in turn endanger life or cause electrical shock to the operator.
- 2) Circuit breaker or mains switch must be installed between power source and supply terminal to facilitate power 'ON' or 'OFF' function. However this mains switch or circuit breaker must be installed at convenient place normally accessible to the operator.
- 3) Use and store the instrument within the specified ambient temperature and humidity ranges as mentioned in this manual.



SAFETY PRECAUTION

All safety related codifications, symbols and instructions that appear in this operating manual or on the equipment must be strictly followed to ensure the safety of the operating personnel as well as the instrument.

If all the equipment is not handled in a manner specified by the manufacturer, it might impair the protection provided by the equipment.



Read complete instructions prior to installation and operation of the unit.



WARNING : Risk of electric shock.

WARNING GUIDELINES



WARNING : Risk of electric shock.

- 1) To prevent the risk of electric shock, power supply to the equipment must be kept OFF while doing the wiring arrangement. Do not touch the terminals while power is being supplied.
- 2) To reduce electro magnetic interference, use wire with adequate rating and twists of the same of equal size shall be made with shortest connection.
3. Cable used for connection to power source, must have a cross section of 1mm or greater. These wires should have insulations capacity made of at least 1.5kV.
- 4) A better anti-noise effect can be expected by using standard power supply cable for the instrument.

PARAMETER SETTING

- Password 11** : To Enable / Disable trip parameter (Over current, Under current, Asymmetry, Single phase prevention)
- Password 73** : To set trip value of Over current, Under current, Asymmetry percentage
- Password 37** : To set Power on time, ITD, Trip delay time, reset Mode, Relay Fault mode, Power Fail Fault Memory ,C.T ratio

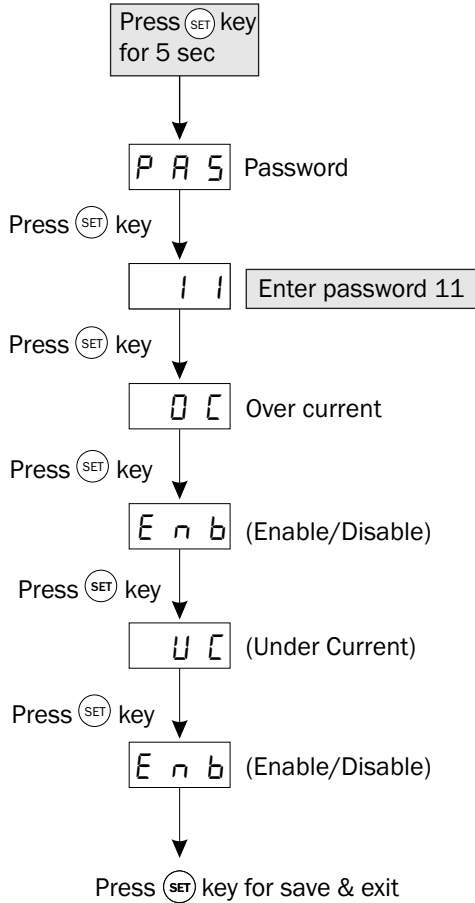

NOTE :-

- If Auxiliary supply cut out without fault Reset, Then fault will be display at next power on.
- To Reset fault press RST key.

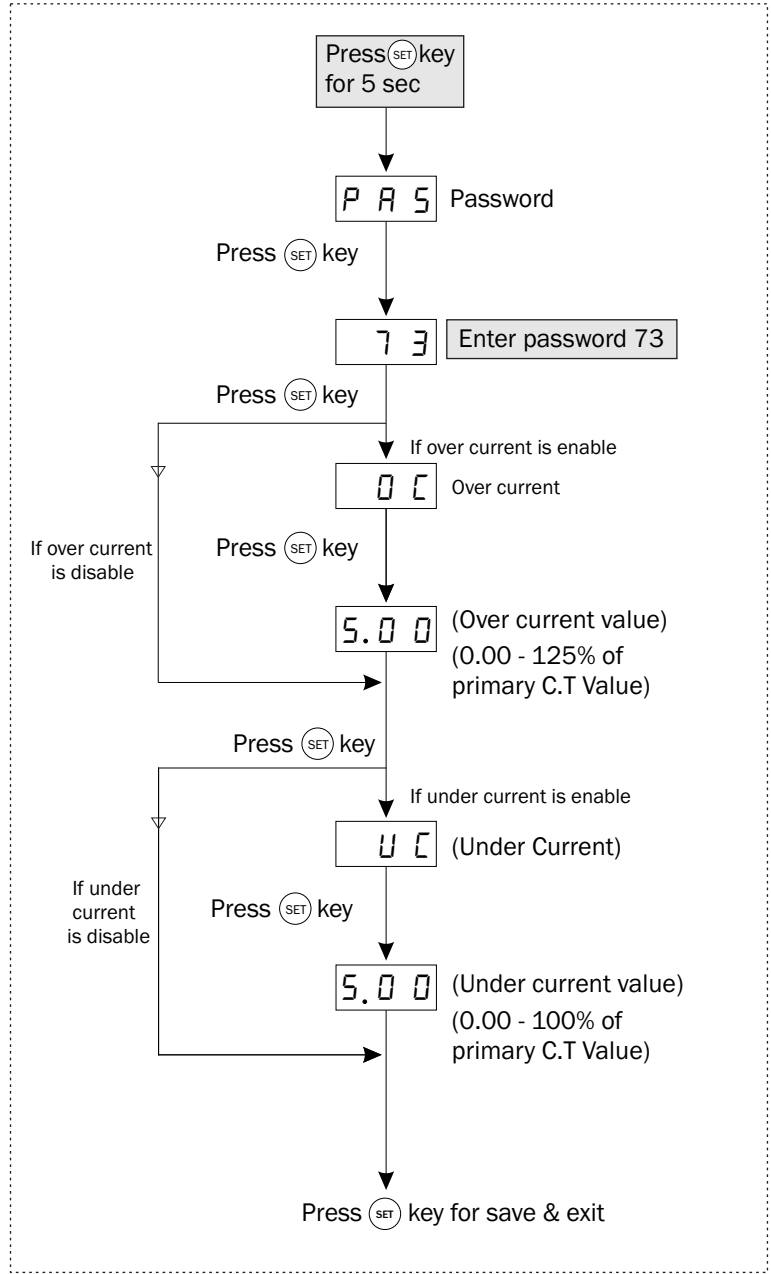

FAULT MESSAGE

<div style="display: flex; align-items: center; justify-content: center;"> <div style="text-align: center;"> <small>R</small> <small>O</small> <div style="border: 1px solid black; padding: 2px; width: 40px; height: 20px; margin: 5px auto;">OC</div> </div> <div style="margin: 0 10px;">← Scroll →</div> <div style="text-align: center;"> <small>R</small> <small>O</small> <div style="border: 1px solid black; padding: 2px; width: 40px; height: 20px; margin: 5px auto;">34.5</div> </div> </div>	<p>Over current Value = 34.5 A</p>
<div style="display: flex; align-items: center; justify-content: center;"> <div style="text-align: center;"> <small>R</small> <small>O</small> <div style="border: 1px solid black; padding: 2px; width: 40px; height: 20px; margin: 5px auto;">UC</div> </div> <div style="margin: 0 10px;">← Scroll →</div> <div style="text-align: center;"> <small>R</small> <small>O</small> <div style="border: 1px solid black; padding: 2px; width: 40px; height: 20px; margin: 5px auto;">10.0</div> </div> </div>	<p>Under current Value = 10.0 A</p>

Press (SET) key **P A S** Password Press (SET) key for 5 sec
 Press (SET) key **3 7** Enter password 37
 Press (SET) key **P O n** Power on time
 Press (SET) key **2 0** (0-99 sec)
 Press (SET) key **i t d** (Initial time delay)
 Press (SET) key **2 5** (0-99 sec)
 Press (SET) key **t d L** (Trip delay time)
 Press (SET) key **2** (0-999 sec)
 Press (SET) key **r s t** (Reset mode)
 Press (SET) key **A U t** (Auto / Manual / ZVR)
 If Auto/ZVR reset mode select
 Press (SET) key **r c t** (Recovery time)
 If manual reset mode select
 Press (SET) key **5** (0 to 99 sec.)
 Press (SET) key **r F i** (Relay fault mode)
 Press (SET) key **0 n** (On/Off)
 Press (SET) key **P F i** Power Fault Memory
 Press (SET) key **0 n** ON / OFF
 Press (SET) key **C t r** Primary C.T ratio
 Press (SET) key **5** (5-999 AmP)
 Press (SET) key for save & exit

Over Current

Over Current - Enable
RLY fault - OFF

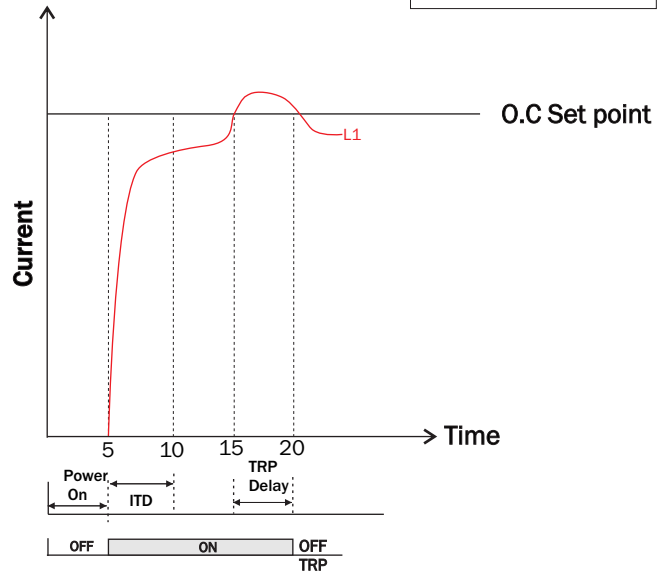

CONTROL FUNCTION

Power on time = 5 sec
Trip delay time = 5 sec

Initial time delay = 5 sec
Reset mode = Manual

Under Current

Under Current - Enable
RLY fault - OFF

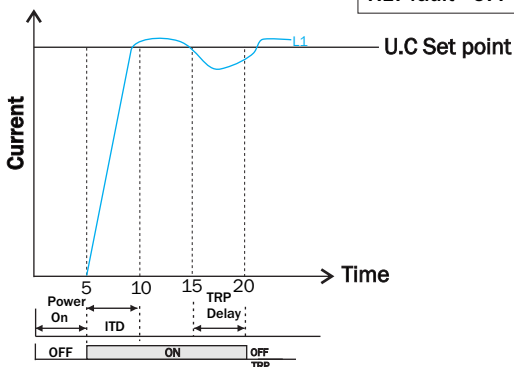

Specifications are subject to change, since development is a continuous process,
So for more updated operating information and Support,
Please contact our Helpline: 9978991474/76/82 or
Email at service@multispanindia.com Ver:01122020